

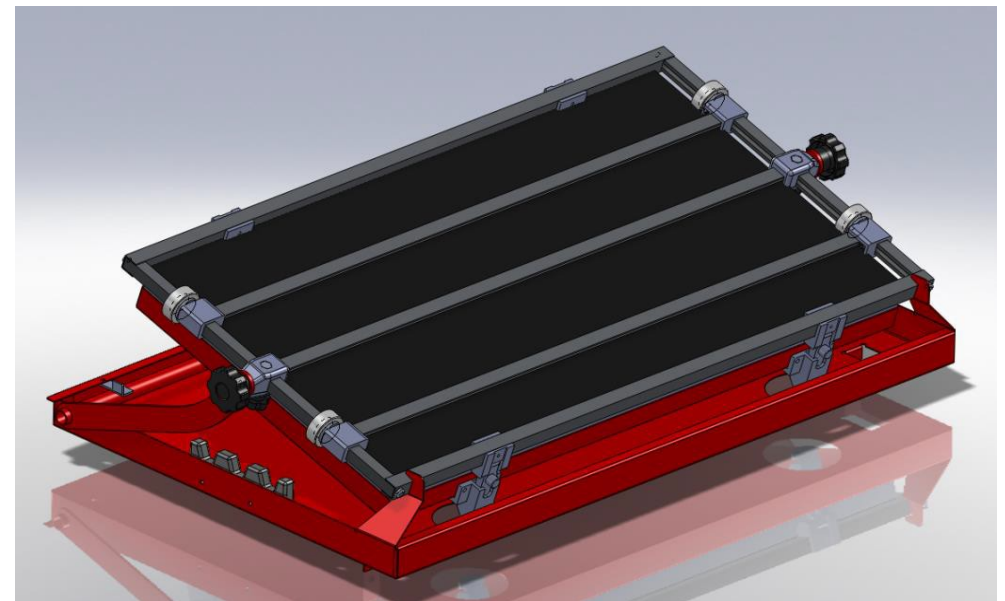

ideal-tek s.a.

manufacturer of high precision tools and instruments

ISO 9001
BUREAU VERITAS
Certification

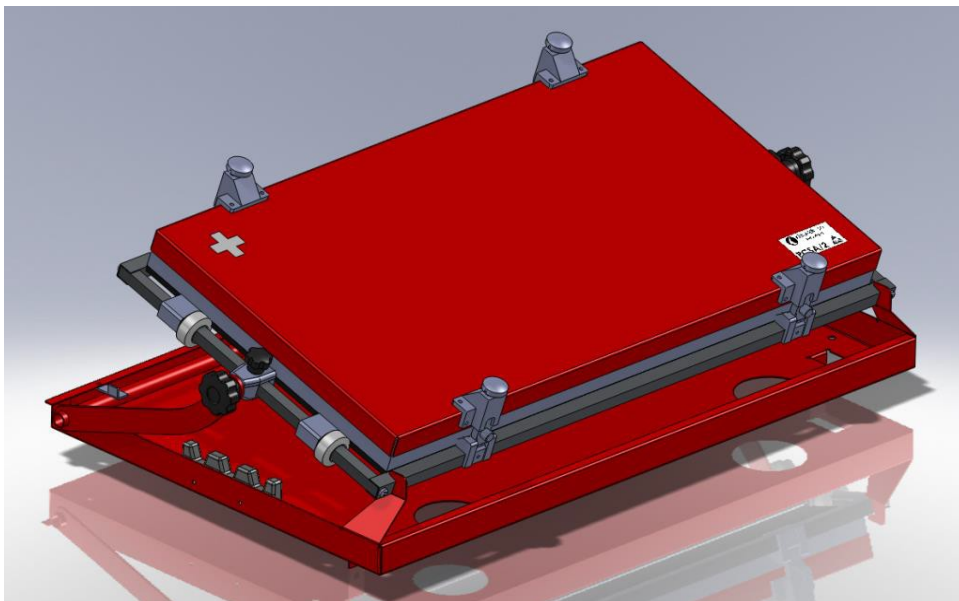

PCSA CIRCUIT BOARD HOLDER

<p>PCSA-1 work surface: 280x220</p>	<p>PCSA-2 work surface: 510x220</p>	<p>PCSA-4 work surface: 510x350</p>
		
<p>Additional splint: BS-PCSS-1 Additional foam: PCSA-1.2</p>	<p>Additional splint: BS-PCSS-2-4 Additional foam: PCSA-2.2</p>	<p>Additional splint: BS-PCSS-2-4 Additional foam: PCSA-4.2</p>

Standard configuration:

- 2 splints (sliding rail)
- 1 central removable middle bridge
- 1 cover
- 1 foam rubber ESD safe

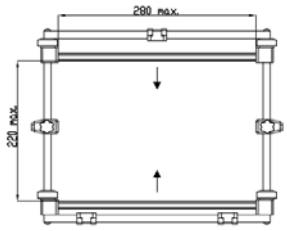
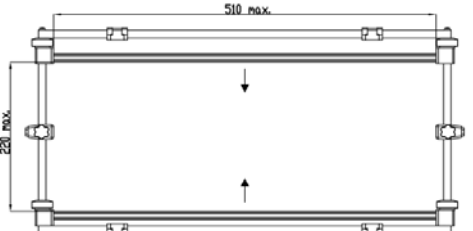
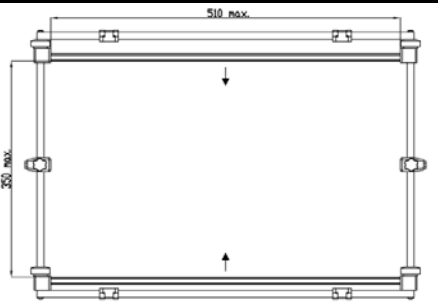
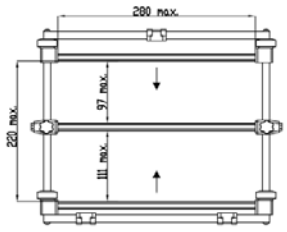
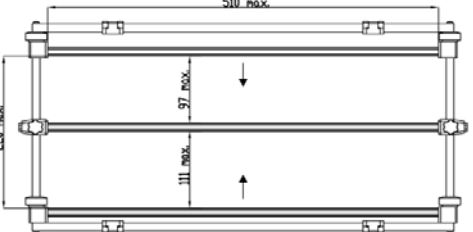
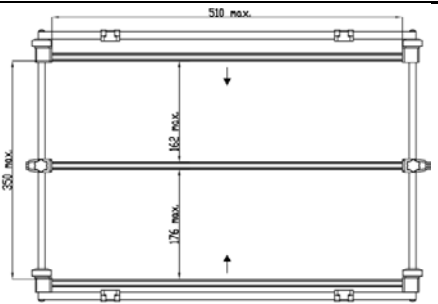
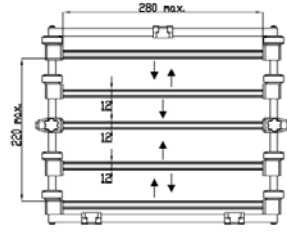
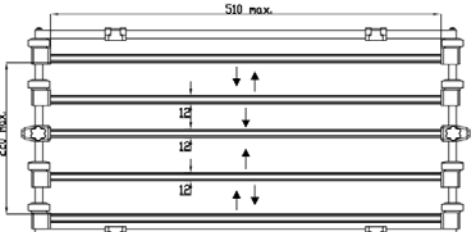
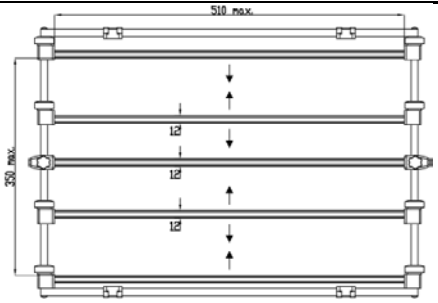
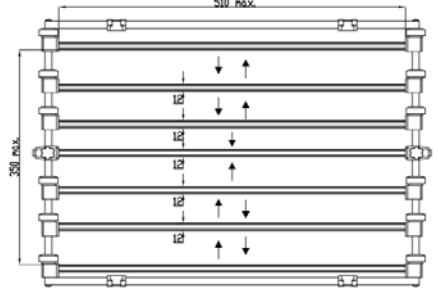
	PCSA-1	PCSA-2	PCSA-4
BRIDGE = 0 SPLINT = 2			
BRIDGE = 1 SPLINT = 2			
BRIDGE = 1 SPLINT = 4			
<p>FEATURE:</p> <ul style="list-style-type: none"> - Circuit board holders of the PCSA series are the ideal tool for fitting circuit boards with components. The holder can easily be demounted in single parts and be reassembled in different combinations. - The standard models PCSA-1/2/4 are equipped with 1 removable middle bridge and 2 adjustable splints. Thus two work areas can be created. - Any circuit board holders can be fitted with additional subdivisors (4 for PCSA-1/2 and 6 for PCSA-4). That way small circuit boards can be used on several levels. 			BRIDGE = 1 SPLINT = 6
			

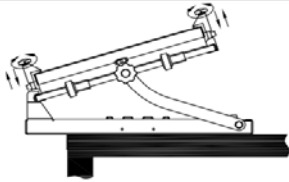

PC Assembly jig with component-press lid closed screwed or clamped to work-top, in relation to the height of the components.

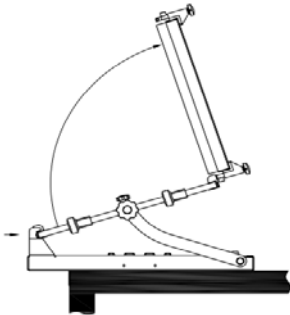

Foam rubber-lined lid for holding components in place. May be raised by applying pressure to front buttons.

Easy to unslot and detach various parts. (Frame-PC holder unit-component-Press Lid).

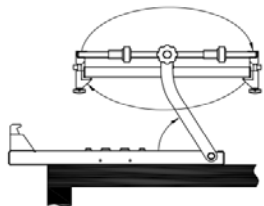

PC board assembly jig can be raised by turning lateral knobs. Self-adjustment to frame at right working angle, after unit raising.

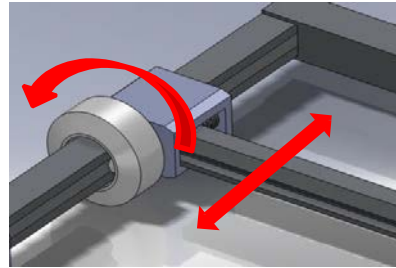

Sliding rails may be positioned by means of self-locking sleeves. A system of springs makes it possible to insert and remove printed circuit boards without changing position of sleeves.

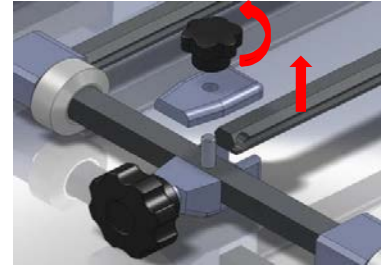

Turn the knob to remove the middlebridge.

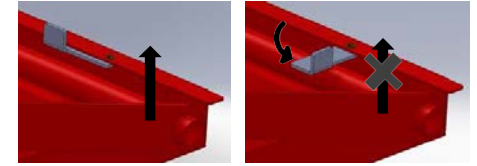

Moveable couplings, located on the rear side of the assembly jigs for attaching the PC assembly jig to the frame. These couplings keep the PC assembly jig from detaching from the frame.

Using pc board assembly jig in vertical position

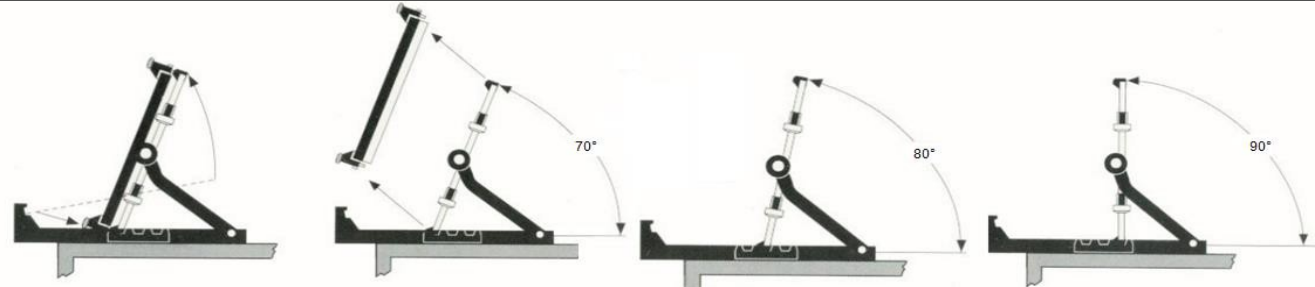
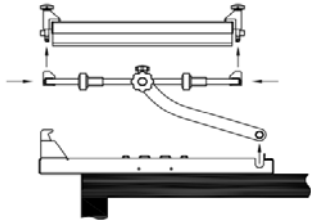

Positioning of the lower corners of the PC Assembly Jig in the toothed guides located on the frame.

Positioning at 70° angle

Positioning at 80° angle

Positioning at 90° angle

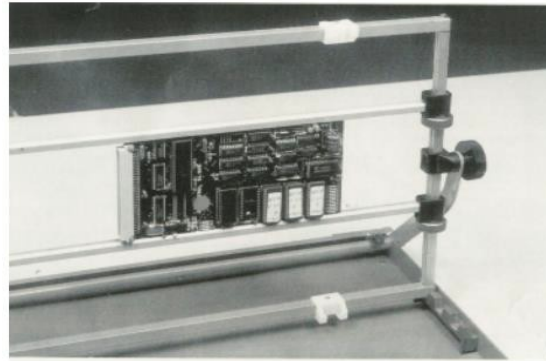

Practical use of PC Assembly Jig with PC Board in place.

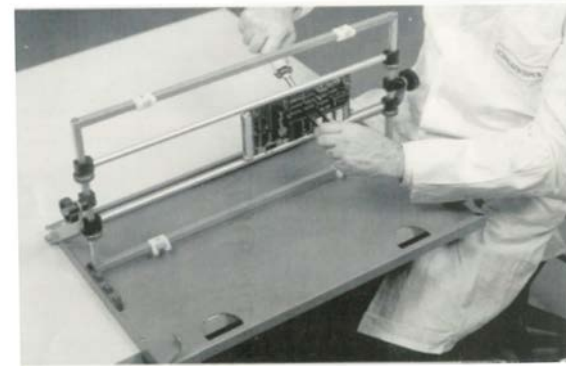

Unsoldering of components carried out with PC Assembly Jig in vertical positions.

PCSA-1

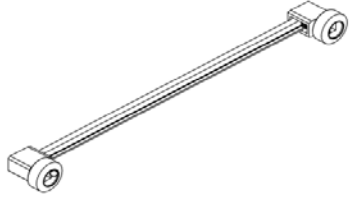

BS-PCSS-1: Sliding rail

PCSA-2

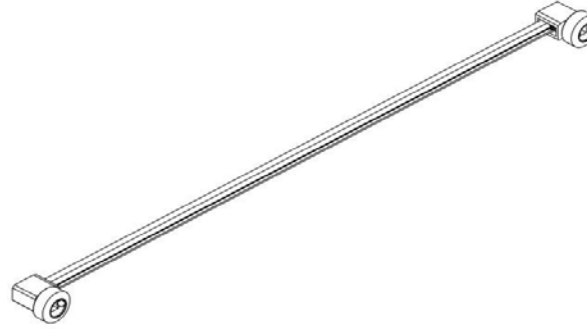

BS-PCSS-2-4: Sliding rail

PCSA-4

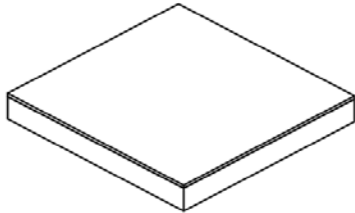

PCSA-1.2: Foam

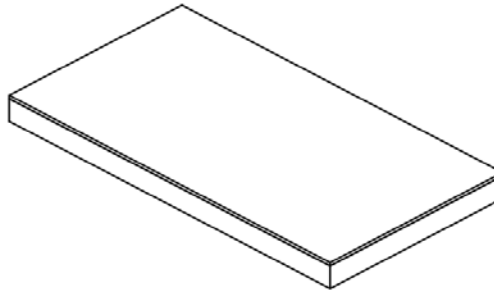

PCSA-2.2: Foam

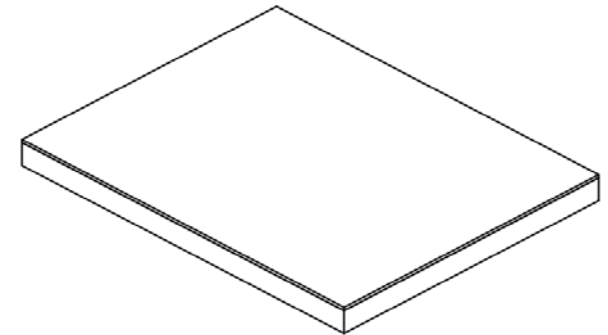

PCSA-4.2: Foam

PCSA-1 PCSA-2 PCSA-4

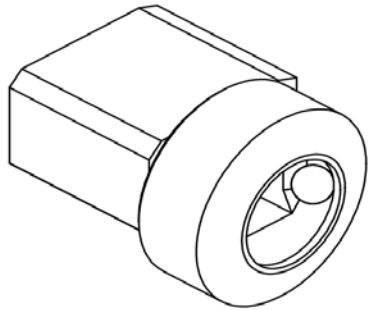

BS-PCSS-NBS: Sliding block

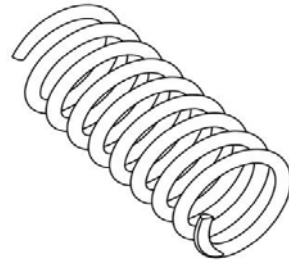

MO-BS-PCSS: Spring

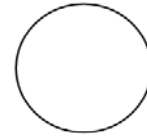

SF-BS-PCSS: Ball diam. 5 mm

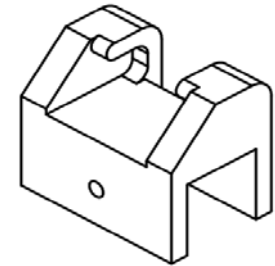

IN-PCSS: Cover support

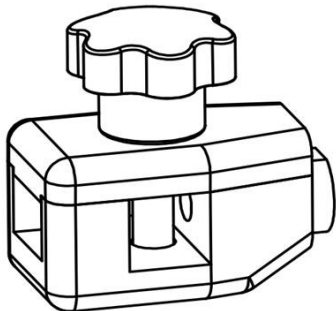

AC-PCSA: Bush-Knob-Screw

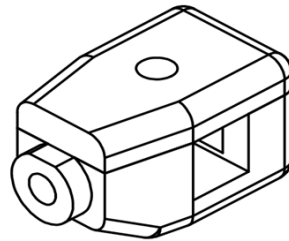

SR-PCSA: Bush

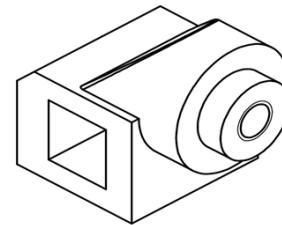

SR-PCSS: Bush (old)

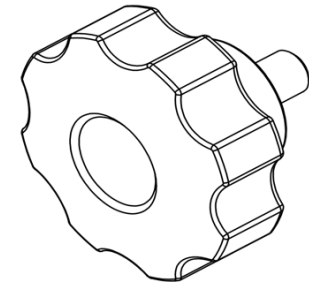

PR-PCSS: Knob

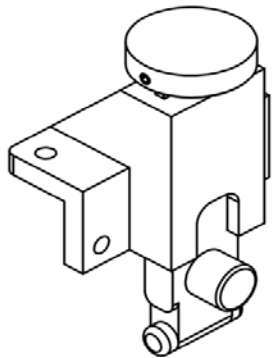

RIC-PCSA-N15: Pivot

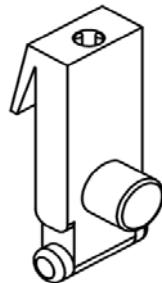

SC-PCSS: Cover clip lever

